



All-around Fiber Laser Machine



# BREVIS 1212 AJ



**3kW**



# A compact fiber laser machine like never before

BREVIS is an all-around fiber laser machine that meets customer needs for cutting thin-to-thick materials.

It's a user-friendly machine that is compact and equipped with the latest features and can be used easily regardless of operator's experience.



All-around Fiber Laser Machine

## BREVIS 1212 AJ

3kW

BREVIS means "small" in Latin.

### Sample

Material type / thickness : SECC 1.0mm  
Size : 280 × 108mm  
Cutting speed : F27000

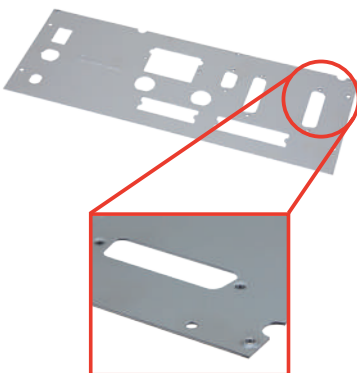

Thin plate, high speed combination processing  
\* OVS-D (option) is used

Material type / thickness : SS400 12.0mm  
Size : 100 × 100mm  
Cutting speed : F1100

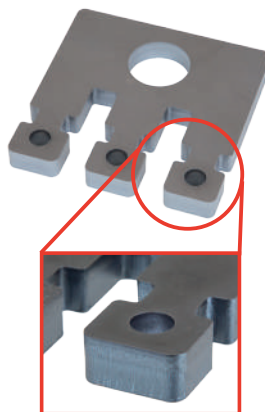

Mild steel, thick plate stable processing

Material type / thickness : SPHC 4.5mm  
Size : 362 × 142mm  
Cutting speed : F3400

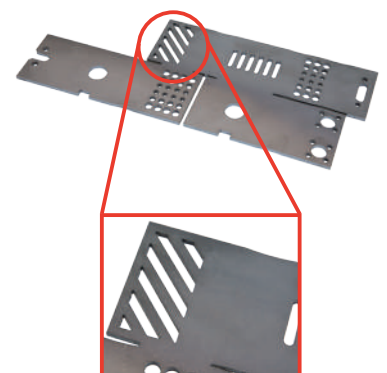

High speed cutting of mild steel,  
medium-thick plate



## ■ Compact

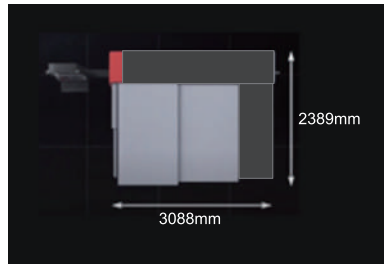
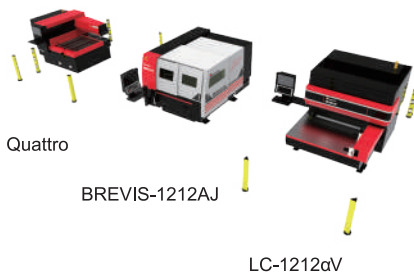

The long-awaited compact size fiber lasers are now available!

A versatile 4' x 4' size fiber laser machine achieves the same installation space as the LC-1212α series.

## ■ All-around

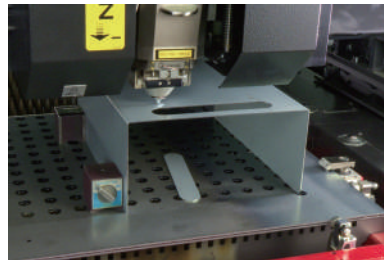
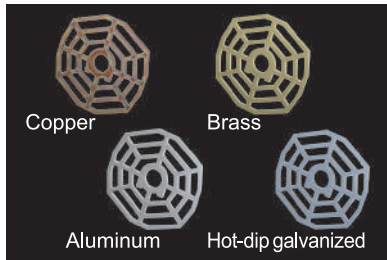

BREVIS can process highly reflective materials such as copper, brass, aluminum and hot-dip galvanized, which are difficult to process with a CO<sub>2</sub> laser. Equipped with a 3kW fiber laser oscillator, it can provide a wide range cutting of thin-to-thick materials. In addition, additional processing on 3D objects can be easily processed.

## ■ User friendly



1



2

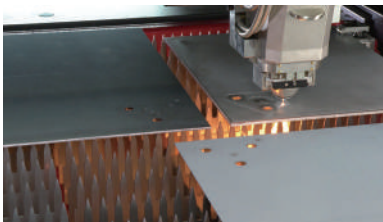

3

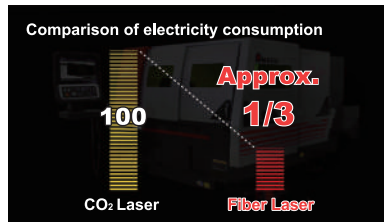

4

### 1 AMNC 3i

Equipped with AMNC 3i that can be used like a smartphone, it fully supports customers.

### 2 Fully open partition

By adopting a fully open partition, both danger prevention and excellent material access are achieved.

### 3 One-lens operation

The entire material range can be processed with a single lens.

### 4 Energy Saving

Equipped with a fiber laser oscillator, it greatly contributes to the reduction of running costs.

## ■ Option

### i-CAS



Camera based on-screen nesting and positioning is available.

### Chuck Index

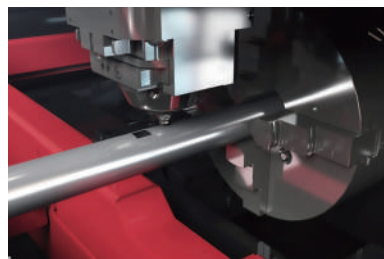

Equipped with a chuck index, it's possible to process not only flat plates but also tubes.

### OVS-D

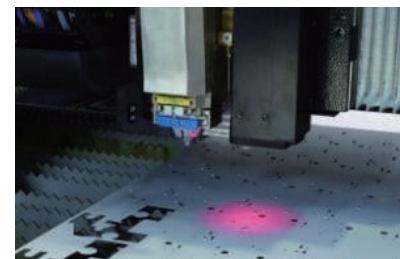

The hole position processed by punching machines is measured and the origin position is corrected, enabling combined processing.

## ■ Dimensions

Unit: mm

■ BREVIS-1212AJ  
(L : 3088 × W : 2389 × H : 1900)

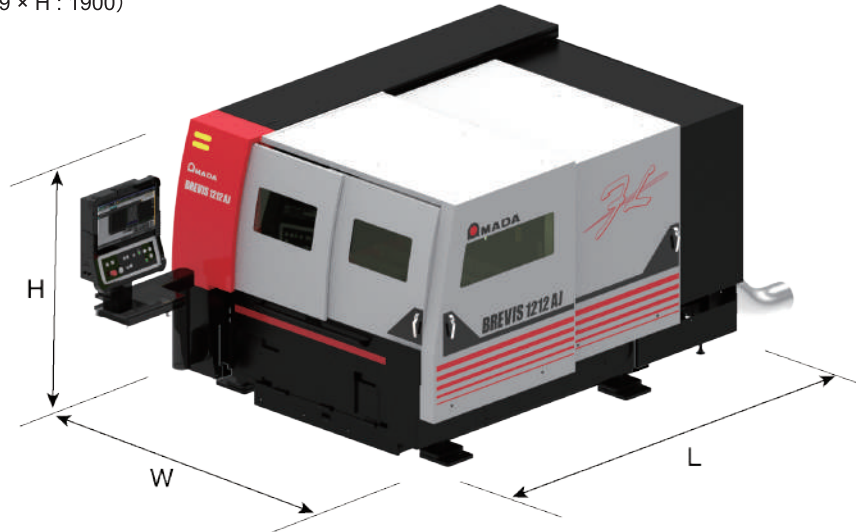

## ■ Machine specification

Machine model			BREVIS-1212AJ	
Registered machine name			BRE1212AJ	
Max. axis travel	X×Y×Z	mm	1270×1270×200	
Max. sheet size	X×Y	mm	1270×1270	
Rapid feed rate	X/Y/Z	m/min	40/40/60	
Max. material weight		kg	150	
NC model			AMNC 3i	
Control method			X, Y and Z-axes (Simultaneous 3 axes control) + B, CF-axes	
Min. setting unit		mm	0.001	
Oscillator	Oscillator method		Laser diode-pumped fiber laser	
	Rated laser power	W	3000	
Machine weight (Main body only)			kg	4800
Power requirement (Chiller, dust collector included)			kVA	25

- \* Specifications, appearance, and equipment are subject to change without notice.
- \* Please use the registered model name for applications related to the administration of the machine or device described in this catalog (installation notification, export, financing, etc.).
- \* The hyphenated spellings like BREVIS-1212AJ are used in some parts of this catalog for the sake of readability. This also applies to other machines.
- \* The specifications described in this catalog are for the Japanese domestic market.



**For your safe use, be sure to read the operator's manual carefully before use.**

- When using this product, precautions are necessary to avoid unsafe operation. For more information about safety guidelines, please see product introduction at AMADA's website ([www.amada.co.jp](http://www.amada.co.jp))



**This laser product uses a class 4 invisible laser for processing and a class 3R visible laser for positioning.**

- Class 4 invisible laser: Avoid eye or skin exposure to direct or scattered radiation. Never look into the radiation nor touch it.
- Class 3R visible laser: Avoid direct eye exposure.

© AMADA CO., LTD. All Rights Reserved.

**AMADA CO., LTD.**

[www.amada.com](http://www.amada.com)

inquiry



E133-HQ02en

Jan. 2022