

SOLUTION



Hybrid drive system
High speed & high accuracy press brakes

HG SERIES

HG-5020/8025/1303/1703/1704/2203/2204

Bending

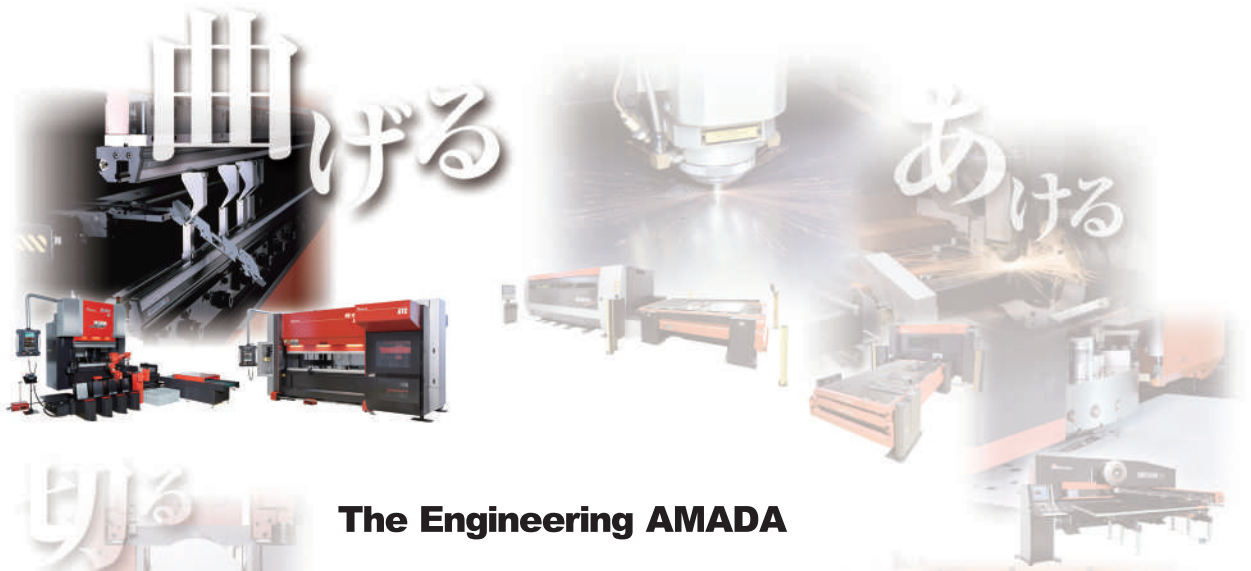
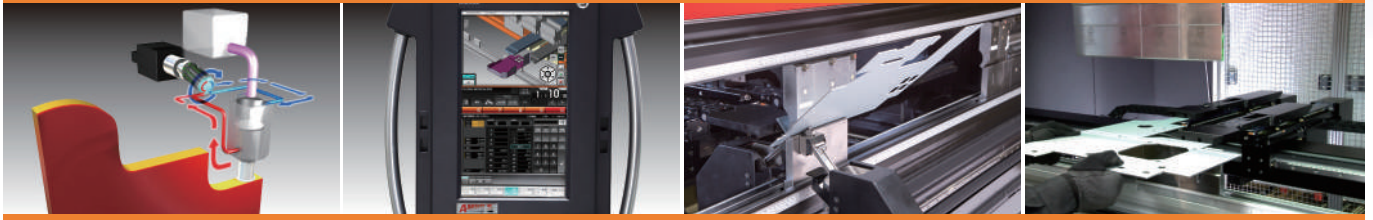

The Engineering AMADA



A total solution with **High speed and Accuracy** for every production environment

Hybrid press brakes to meet needs in production

The HG series is the one of latest high end press brakes tailored for changing production environments. A high rigidity frame and a new hybrid system combine to expand the processing range further. While bending workpieces with the world's highest speed and accuracy, the HG series press brakes save more energy than conventional press brakes and provide improved working environments. A variety of bend angle solutions support inexperienced operators in achieving the target bend angle from the first part without test bending.

A newly developed NC unit has display functions strengthened to allow operators to check forming information in real time and to contribute to easier operation and shorter lead time.



HG-1303



HG-8025

Hybrid drive system
High speed & high accuracy press brakes

*Options are included in the photos.

HG SERIES

Processing examples with representative sample workpieces

(Productivity comparison with conventional press brakes)

Material: SECC 1.6mm
Size: 194.6×414.2mm

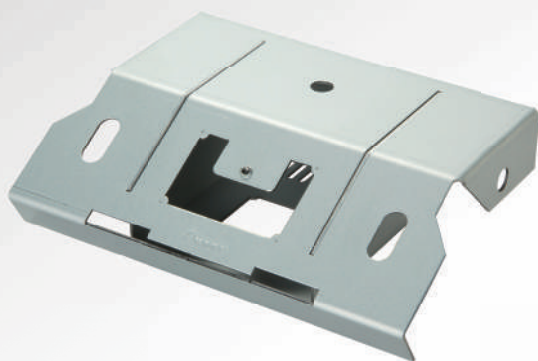

Processing time comparison
60% Reduction

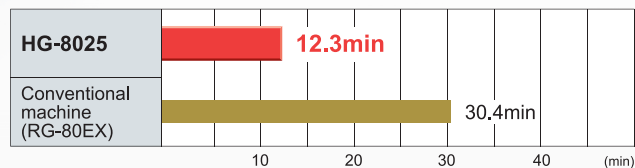

Material: SUS 1.2mm
Size: 334.4×288.8mm



Processing time comparison
71% Reduction

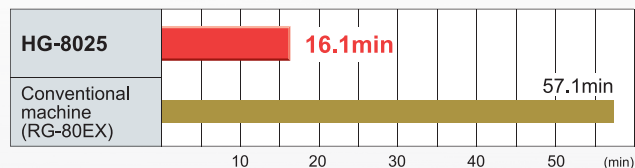

Material: SECC 1.6mm
Size: 531.9×180.8mm

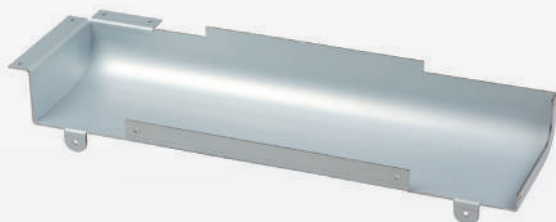

Processing time comparison
58% Reduction

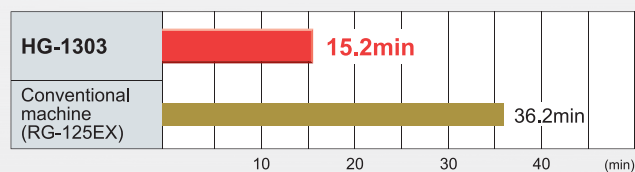

Material: SECC 1.6mm
Size: 857.6×283.6mm



Processing time comparison
50% Reduction

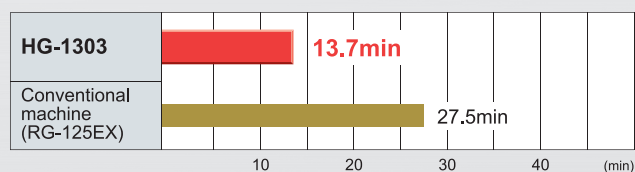

HG series New technologies

1 Achievement of easy operation

AMNC 3i

Adopts a multiple touch LCD screen and incorporates a user-centered design philosophy. Operators can operate the machine intuitively from the touch screen as when they do with a smart phone and with greater ease. The display size is increased from a conventional horizontal 15 inch display to a vertical 18.5 inch wide display. Operators can check programs and necessary bending information at a glance. The augmented display functions allow forming information to be displayed in real time.

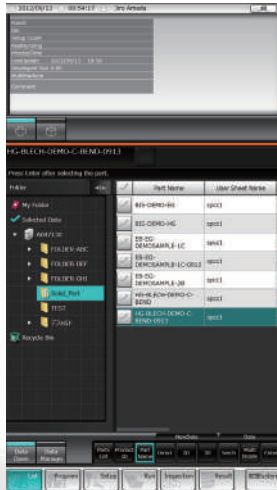

Program call



Bend sequence



Setup



Processing



2 High speed and high accuracy bending of thin to thick materials

Maximum productivity achieved with minimum energy

1 New hybrid drive system/hybrid crowning system

Variable hydraulic piston pumps are combined with highly accurate servo motors to achieve the world's highest levels of production speed and energy conservation. A hybrid crowning system that can accommodate an upper pressure limit of 500% ensures a bend angle accuracy of $\pm 15'$ anywhere along the length of the bed on all of the HG series press brakes.

Speed/stroke length comparison

	HG-8025	Conventional machine (FBDIII-8025)
Approach speed mm/s	220	77/90(at 50Hz/60Hz)
Bending speed mm/s	20	8/9 (at 50/60 Hz)
Return speed mm/s	250	90 (at 50/60 Hz)
Stroke length mm	250	150

2 New backgauge system

A new backgauge system is installed to accomplish still higher accuracy and productivity. The L-axis repeatability is ± 0.003 mm.

L-axis speed: 30m/min
Measurement length: 700mm

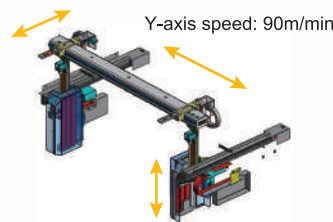

Y-axis speed: 90m/min
2-axis speed: 20m/min
Stroke length: 250mm
Travel range: 30 to 280mm



L-shift (Option)

3 New high rigidity frame/open height extension

A high rigidity frame was designed newly after searching its optimum shape through structural analysis. The high rigidity frame allows for a larger open height and a longer stroke length and hence for a wider deep box bending range.

Solutions for stable processing without test bending

1 Angle sensor (Option)

The Bi-S and Bi-L angle sensors help to achieve the desired bend angle from the first part without test bending.

Bi-S angle sensor (contact type)

- Applicable angles: 80 to 165°
- Applicable material thicknesses: 1 to 6 mm
- Applicable material types: Mild steel, stainless steel, aluminum
- Applicable V-openings: 6 to 40 mm (AFH) 6 to 25 mm (AMTS)
- Number of sensor axes: Auto 1 axis/2 axes

Bi-L angle sensor (noncontact type)

- Applicable angles: 60 to 150°
- Applicable material thicknesses: 1 to 12 mm
- Applicable material types: Mild steel, stainless steel, aluminum (not mirror finished)
- Applicable V-openings: 6 to 100 mm
- Number of sensor axes: Auto 1 axis/2 axes

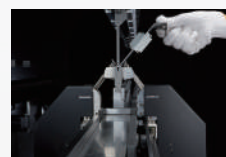

Bi-S



Bi-L

2 Force control

The target force is set to achieve a bend angle of 90°. While the workpiece is bent to the target pressure value, its bend angle is measured and adjusted automatically. The effects of material thickness and property variations are reduced to produce bent parts stably with high quality.



Force control

3 Thickness detection system (TDS)

TDS reads variance of material thickness and compensates depth position automatically for stable and correct bending.

Other functions (including options)

Option

LED lights (front and rear)

LED lights are installed at the front and rear of the upper table. They illuminate the hands of the operator brightly so that the operator can work more efficiently.

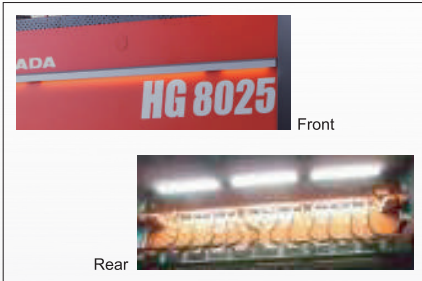

Sheet follower SF-1012TL

The SF-1012TL can handle 50 kg with 1 axis and 100 kg with 2 axes and a maximum material size of 1000 x 2000 mm. It saves on labor, prevents material deflections in bent parts, and supports deep box bending. When not in use, it can be moved to the home position.



Sheet follower SF-1548H

The SF-1548H can handle a maximum worksheet mass of 150 kg and a maximum material size of 1250 x 2500 mm. It saves on labor, prevents material deflections in bent parts, and supports deep box bending. When not in use, it can be moved to the home position.

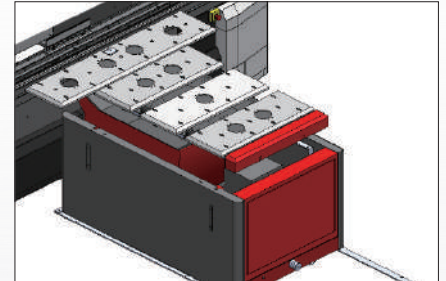

Work support

The work support can be used together with the Bi-S or Bi-L bend angle sensor when bending medium or thick materials that are heavy and thin materials that are likely to develop material deflections.

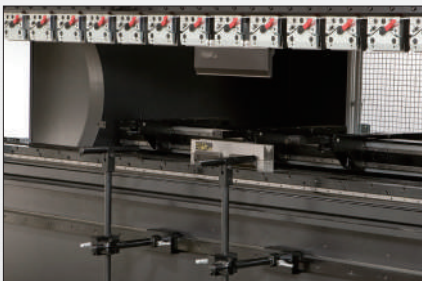

Auto slide foot pedal

The auto slide foot pedal automatically moves left and right in each bending process. It relieves the operator of the task of manually shifting the foot pedal sideways during step bending and contributes to a comfortable processing environment.



Manual slide foot pedal

A foot pedal with a slide mechanism that can be simply moved left and right when pushed by hand. When processing large materials, it can be removed from the slide rail and used like a conventional foot switch.



Safeguarding devices

1 New laser guard device

Ensures that the operator can work safely while maintaining productivity.

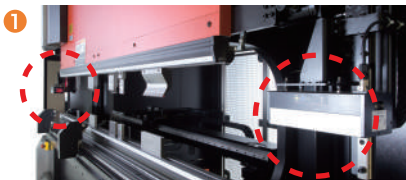

2 Side guard (without interlock)

Prevents access through the side gap.



3 Rear guard

Prevents access from the rear.



4 Emergency stop buttons

Located on the control pendant and at the left and side of the lower beam.



5 Interlock (OFF mode)

The mode selector keyswitch has an OFF mode. When the OFF mode is selected, all axis movements stop.



AGRIP

Amada standard holders for punches with tapered grooves to prevent the punch from falling.

AGRIP-M: Manual type

AGRIP-A: Hydraulic drive type

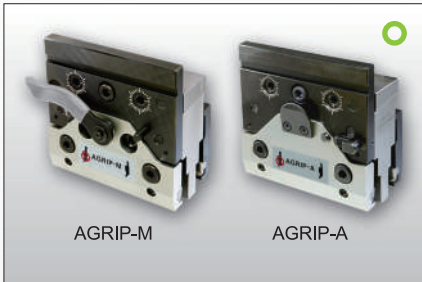

Amada modular tooling system (AMTS)

The clamp pin in the tool holder is hydraulically operated to clamp AMTS tools with one touch. The AMTS tools can be installed in any position and need not be aligned. The safety click prevents the punch from falling and firmly secures the punch.

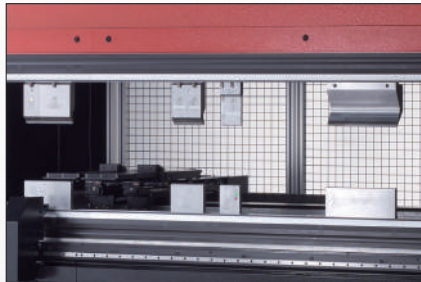

Reversible 1V die holders

Reduce the time to change and setup dies. Prevent sectionalized dies from falling and shifting and obviate the need for aligning the dies each time they are changed.



Hydraulic 1V die holders

Clamp sectionalized 1V dies and AFH dies hydraulically and automatically. Can clamp and unclamp the dies with one touch. The clamp plates are slit to firmly secure thin sectionalized dies.



Backgauge fingers

- ① Detachable fingers
- ② Step-tipped finger
- ③ 90 mm support
- ④ 300 mm stopper

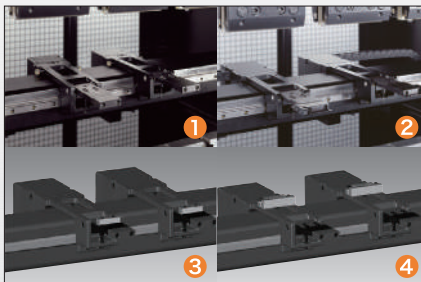

Special backgauge fingers

- ① Work sensor finger (standard)
- ② Work sensor finger (stepped)
- ③ L-shaped
- ④ U-shaped

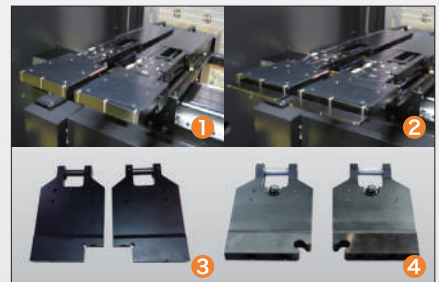

Network system diagram

Amada proposes digital manufacturing based on the core of a virtual prototype simulation system (VPSS). Processing data are created in the office and saved in a data server. These data can be called from the data server through a network and used on the shop floor.

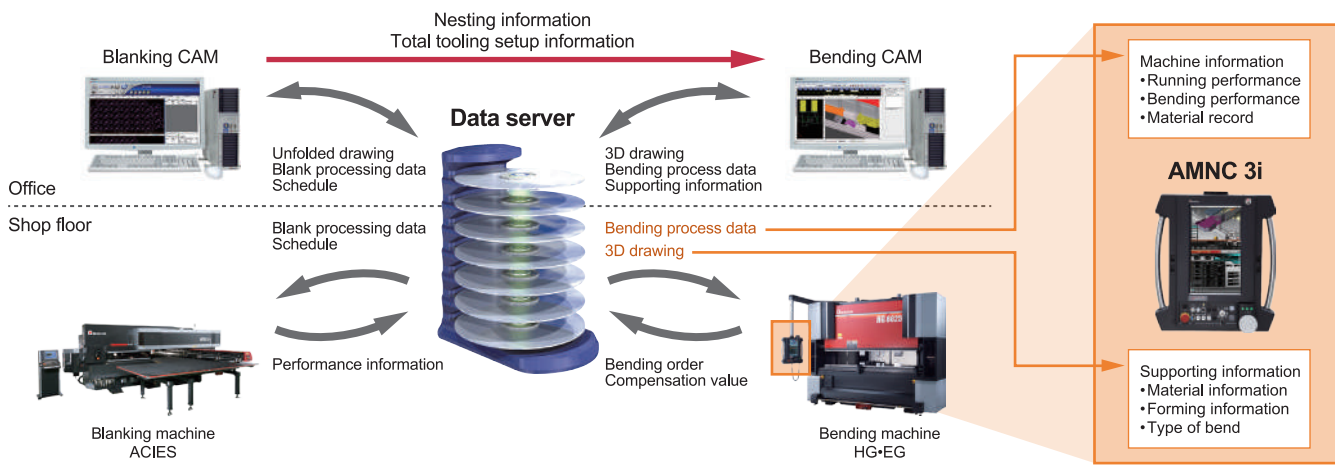

■ Dimensions

Unit: mm

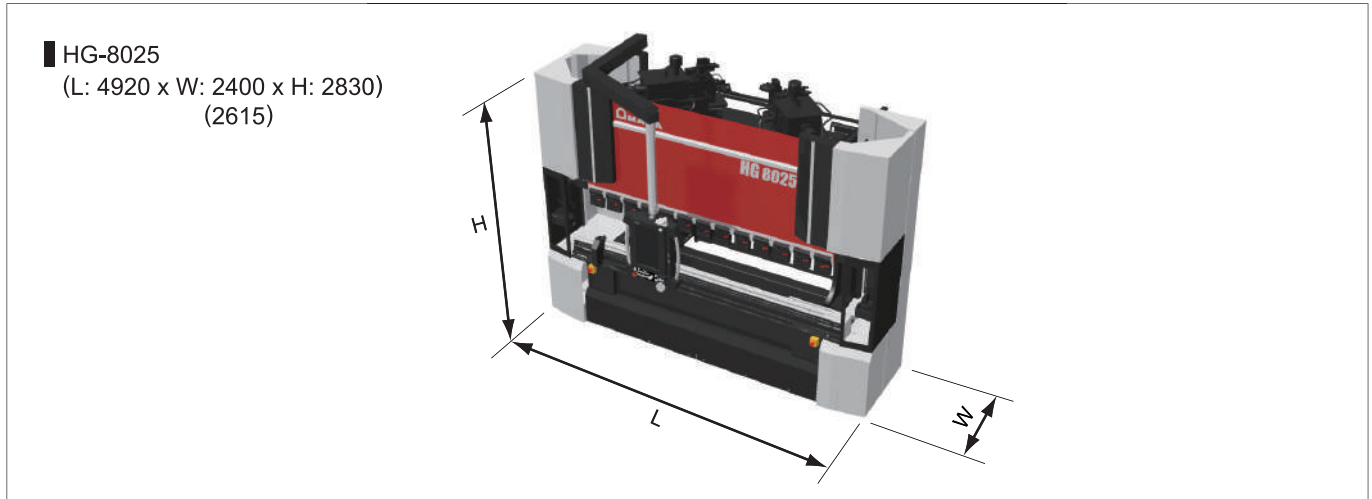

Unit: mm

Model	HG-5020	HG-8025	HG-1303	HG-1703	HG-1704	HG-2203	HG-2204
Distance between frames	1700	2210	2700	2700	3760	2700	3760
Open height	520						
Bed height	950						
Machine width L	3070	3520	4030	4030	5220	4030	5220
Total width L (Maximum footprint)	4435	4920	5455	5455	6580	5465	6590
Total height H	2810	2830	3070	3195	3195	3220	3220
Depth W (with L-shift)	2400 (2615)						

Please refer to profile drawing for measurement in details.

■ Machine specifications

Model	HG-5020	HG-8025	HG-1303	HG-1703	HG-1704	HG-2203	HG-2204
Tonnage capacity	kN	500	800	1300	1700	1700	2200
Table length	mm	2150	2600	3110	3110	4300	4300
Stroke length	mm	250					
Number of cylinders (auxiliary)		2 (2)			2 (3)		
Approach speed	mm/s	220					
Bending speed	mm/s	20					
Return speed	mm/s	250					
Machine mass	kg	5500	7200	11500	15000	18000	17000
Motor power	kW	1.8 x 2 (D)	2.9 x 2 (D)	4.4 x 2 (D)	5.5 x 2 (D)	5.5 x 2 (D)	7.5 x 2 (D)
		1.8 (CC)	2.9 (CC)	2.9 (CC)	5.5 (CC)	5.5 (CC)	5.5 (CC)
Hydraulic oil capacity	L	37.5	39.5	69.5	106.5	106.5	122.5
Primary power supply cable	mm ²	8	14	22	38	38	38
Tilt range (left-right)	D-axis	mm	±5	±10	±15	±15	±20
	L-axis	mm	±320	±500			
Power consumption	kVA	11.8	15.2	20.8	26		34.3

■ AMNC 3i specifications

Display method	18.5" wide multi-touch LCD screen
Axes under CNC control Axes enclosed in parentheses are optional.	8-axis: D1, D2, L1, L2, Y1, Y2, Z1, Z2 (LS1, LS2)
Input method	Touch screen input, axis coordinate value teaching input, bar code input (when networked)
Least input increment	mm D-axis: 0.001, L-axis: 0.01, Y-axis: 0.1, Z-axis: 0.1, CC-axis: 0 to 500%
Feed rate	m/min L-axis: 30, Y-axis: 90, Z-axis: 20
Backgauge measurement length	mm 700
Backgauge finger height range	mm 250 (30 to 280)

⚠ For Your Safe Use
Be sure to read the manual carefully before use.

● Use of this product requires safeguard measures to suit your work.

*Specifications, appearance, and equipment are subject to change without notice by reason of improvement.

*The official model names of machines and units described in this catalog are HG5020, HG8025, HG1303, HG1703, HG1704, HG2203 and HG2204.

*Use these registered model names when you contact the authorities for applying for installation, exporting, or financing.

*The hyphenated spellings HG-5020, HG-8025, HG-1303, HG-1703, HG-1704, HG-2203 and HG-2204 are used in some portions of this catalog for sake of readability.

*The specifications described in this catalog are for the Japanese domestic market.

© AMADA CO., LTD. All Rights Reserved.

AMADA CO., LTD.

www.amada.com

inquiry



E050-HQ02en

Nov.2019