

Press Brake Safety Guide

(For employers and employees)



This safety guide is an English translation of Japanese safety guide based on Japanese laws and regulations.
Please comply with your country's laws and regulations if you are outside of Japan.



**Eighth edition
July 2020**

1. Preface

This safety guide provides employers and employees with important safety information they should know when they take safeguarding measures for AMADA press brakes.

Safety information for using press brakes is also available in the operator's manuals of press brakes and the warning labels affixed to the press brakes. Before you use the machine, fully understand all of these pieces of safety information.

The safety guide introduces safeguarding measures that can be retrofitted to your press brake. Fully recognize hazards associated with machine installation, workpiece and tool setup, machine operation, inspection, cleaning and maintenance, and other tasks. On your own responsibility as employer, take safeguarding measures to suit the environment of your shop and the method of using your machine. Also conduct safety and health education for your operators.

The Industrial Safety and Health Act states that employers must take machine safeguarding measures.

(See "Responsibilities of employer" on the next page.)

Several examples of safeguarding are introduced here. Safeguarding devices recommended by AMADA are offered as options. Please study and adopt them.

For machine safeguarding procedures, etc., refer to "Guidelines for the Comprehensive Safety Standards of Machinery" published by the Ministry of Health, Labour and Welfare (LSB Notification No. 0731001, revised on July 31, 2007).

To see the guidelines, go to the website of the Japan Advanced Information Center of Safety and Health (<https://www.jaish.gr.jp>), click the "Laws, Regulations and Notifications" button, enter "No. 0731001", and find the LSB Notification No. 0731001.

When you retrofit safeguarding devices to your already installed machine, you may have to modify the machine and its controls. When you study what safeguarding devices to adopt, please contact AMADA.

2. Responsibilities of employer

The Industrial Safety and Health Act (hereinafter referred to as Act) and Ordinance on Industrial Safety and Health (hereinafter referred to as Ordinance) mainly impose the following duties on employers who have their workers use machines, in order to reduce industrial accidents.

(1) Notifying of plans

- Notify the Labour Standards Office of plans.

Notify the Labour Standards Office of plans to install, relocate or alter machines, etc.
(Article 88 of Act and Article 85 of Ordinance)

Notify the Labour Standards Office of such plans, have the plans checked for safety, and receive guidance about the plans.

- Notify the competent government office of a specified facility and apply to the competent government office for permission to use the specified facility.

If the specified facility falls under the provisions of the Noise Control Act, the Vibration Control Act and the environmental conservation ordinance of the competent local government, notify the competent environmental conservation contact office of the specified facility.

Since the notification duties, control values, etc., vary from region to region, check the details at the competent environmental conservation contact office.

(2) Investigating hazardousness and harmfulness

Investigate the hazardousness and harmfulness of tasks and duties (or assess the risks of tasks and duties). Take necessary measures to prevent hazards to workers or prevent the health disorders of workers. (Article 28-2 of Act)

For data concerning residual risks peculiar to specific machines and required to perform risk assessment, contact AMADA.

(3) Preventing hazards

Take appropriate safeguarding measures to ensure the safety of press operators. (Article 20 of Act and Article 131 of Ordinance)

Protect workers from hazards from machines, hazardous materials, and electricity and other energy sources.

Take measures to prevent the body parts of workers from entering the hazardous area.

(4) Appointing chief operator

Appoint a qualified chief operator. (Article 14 of Act and Article 16 of Ordinance)

In a workplace with five or more power presses, appoint a chief operator from among workers given technical training.

(5) Conducting safety and health education

Conduct safety and health education to workers who operate the machine for the first time. (Article 35 of Ordinance)

Provide special education to workers who change or adjust tools. (Article 36 of Ordinance and Article 3 of Rules on Special Safety and Health Education)

(6) Inspecting before start of day's work

Inspect the machine before the start of the day's work. (Article 136 of Ordinance)

Try to find equipment failures and faults as soon as possible. If a problem is found, repair it or take any other necessary measure to prevent an accident.

(7) Conducting special voluntary inspection

Conduct legal inspection by qualified personnel once or more per year. (Article 135 of Ordinance)

Repair any problems found by the inspection, and file the inspection results and repair records.

3. Introduction of safeguarding measures

(1) Light curtain

Light beams are projected at the front of the point of operation. When an obstruction interrupts the light beams during the ram fast stroke, the ram stops. The ram does not stop during the opening process as the obstruction interrupts the light beams. To ensure a safety distance, the light curtain cannot be used when bending small parts and parts with long side flanges unless the function is muted.

For higher safety, it is necessary to provide auxiliary light beams as shown below if the operator is likely to reach between the main light beams and the front edge of the bed. It is also recommended to install side guards (Note 2) at the sides of the machine.

Note 1: Light curtains are called safety device when certified so by the Ministry of Health, Labour and Welfare.

Note 2: For side guards, see section (3).

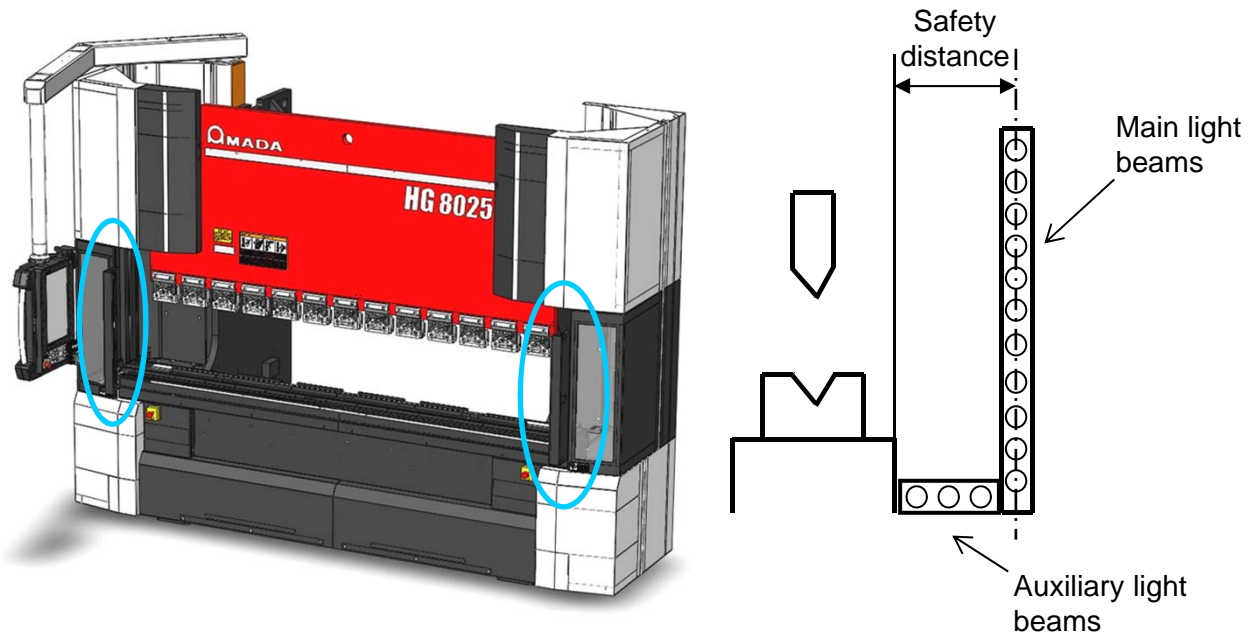

The following equation for calculating the safety distance is specified in the Power Press Construction Code(Japanese Law):

$$D = 1.6 (T_I + T_s) + C$$

Where

D: Safety distance (mm)

1.6: Operator's hand speed (m/s)

T_I: Time from interruption of light beams by operator's hand to operation of light curtain (ms)

T_s: Time from operation of light curtain to stop of ram (ms)

C: Distance added for press brake (0 mm when minimum object sensitivity (MOS) is 30 mm or less)

T_s is sudden stop time and T_I + T_s is maximum stop time.

*T_I and T_s vary with the safety devices used and the machine.

(2) Laser beam device

Two or more laser beams are projected between the punch and die at the point of operation. When an obstruction interrupts the laser beams during the ram closing process, the ram stops. The ram does not stop during the opening process as the obstruction interrupts the laser beams. The laser beams are located just below the punch. This means that the laser beam device can be used when bending small parts and parts with long side flanges. When the ram comes to the mute point, it decelerates to a crawl speed of 10 mm/s or less. The laser beam device complies with the type test requirements of Japan and is CE marked as category 4.

Note 1: Bending from the mute point involves the risk of getting hands pinched between the workpiece and tool/upper beam.

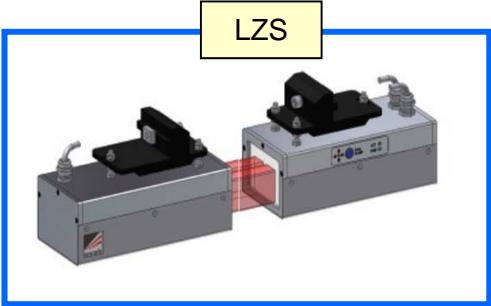
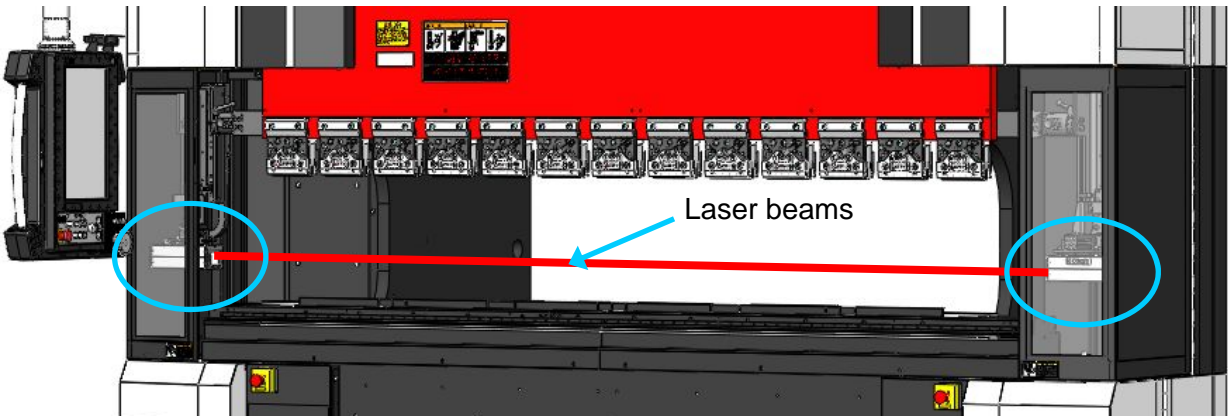

The ram stops when the laser beams are interrupted if speed is over 10mm/sec.

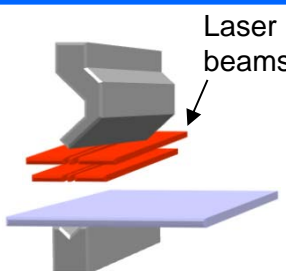
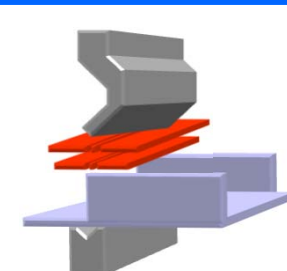
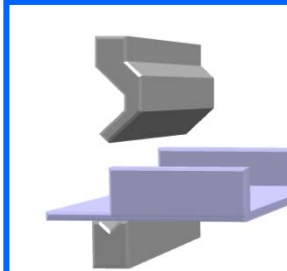
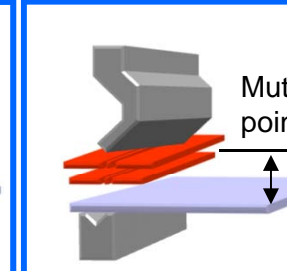
Normal mode	Box mode	Field muted mode	Mute stop mode
 <p style="font-size: small;">Laser beams</p> <p style="font-size: small;">Workpiece without standing side flanges</p>	 <p style="font-size: small;">Workpiece with standing side flanges Ram pauses at side flange position and then closes when CLOSING foot pedal is pressed again.</p>	 <p style="font-size: small;">Laser beam device is muted Ram operates only at crawl speed of 10 mm/s or less. This mode is used for changing tools or performing special bending operations (like hemming).</p>	 <p style="font-size: small;">Mute point</p> <p style="font-size: small;">Ram pauses at mute point and then closes when CLOSING foot pedal is pressed again.</p>

(3) Side guards

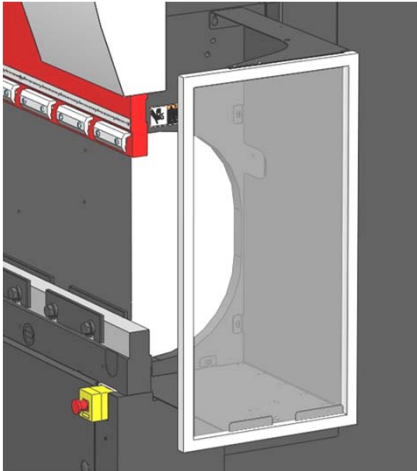

Movable guards at the sides of the machine.

The side guards reduce the risk of the operator getting the hands pinched when the operator reaches between the punch and die from either side of the machine or reaches between the backgauge and tool.

(4) Rear guard

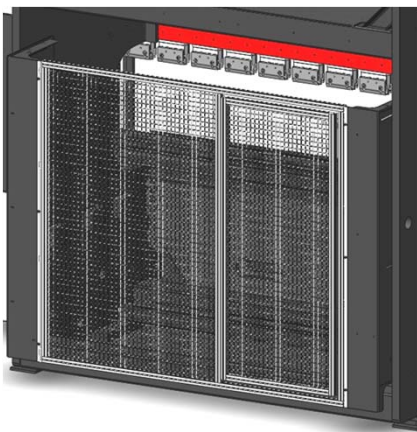

Prevents entry from the rear of the machine. The rear guard reduces the risk of the operator getting the hands pinched between the punch and die or getting impacted by the backgauge.

It is especially effective in protecting operators other than the main and auxiliary operators.

(5) Three-position(Antipanic) foot pedal

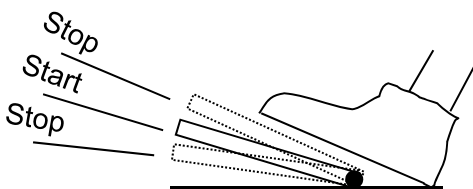

A foot pedal of three-step construction.

The ram is stopped in the first step. Press the foot pedal in the second step to start the ram. Strongly press it in the third step to stop the ram.

If the operator loses balance during the bending operation and strongly press the foot pedal with hands inserted between the punch and die, the ram stops. When feeling a dangerous situation, an operator tends to push hard instead of releasing. In this way, the three-position foot pedal reduces the risk of the operator getting hands pinched between the punch and die.

(6) Sheet follower



Installed at the front of the machine and supports sheets. The operator need not support sheets. When sheets are particularly heavy, the fatigue of the operator is lessened throughout the bending operation.

The sheet follower also reduces the risk of the operator getting injured on the face, for example, by the unexpected whip-up of the sheet.

(7) Stepped stopper fingers

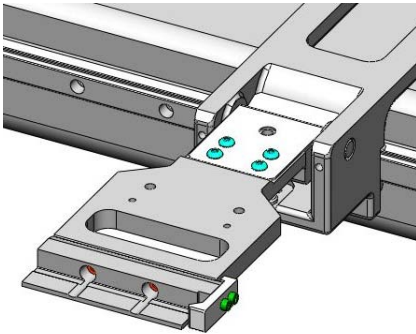

Prevent the workpiece to get out of accurate gauging position, by the step supporting the workpiece end. The workpiece is stable in gauging position, supported by the die and the step on the finger.

This reduces the risk for the operator, since the operator only needs to support the front end of the workpiece and never puts the hand between punch and die.

(8) Two-hand control device



A stand-type control device with two-hand control pushbuttons.

The operator presses and holds the two-hand control pushbuttons until the punch approaches 6 mm of the workpiece.

The operator then feeds the workpiece, presses the foot pedal in place of the two-hand control pushbuttons, and continues to bend the workpiece.

The two-hand control device allows the operator to work at a distance from the point of operation between the punch and die. It helps to prevent the operator from getting hands pinched between the punch and die.

(9) Automatic stroke stop device (two-press operation)

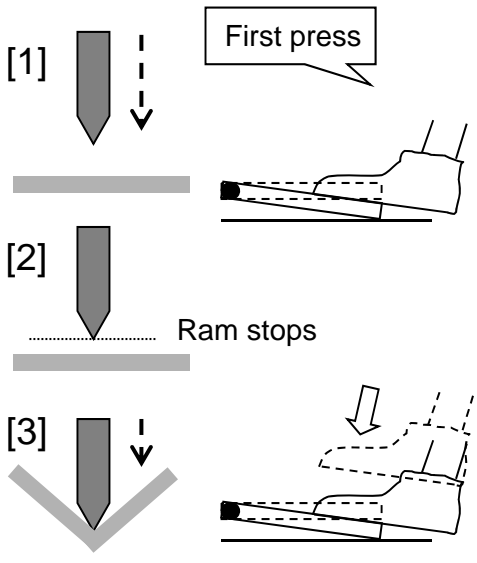

When the operator presses the foot pedal [1], the ram stops as the punch approaches 6 mm of the workpiece [2]. The operator checks for safety and again presses the foot pedal to bend the workpiece [3]. This device allows the operator to securely hold the workpiece and verify workpiece gauging. It reduces the risk of the operator getting hands pinched.

(10) Two-person control device

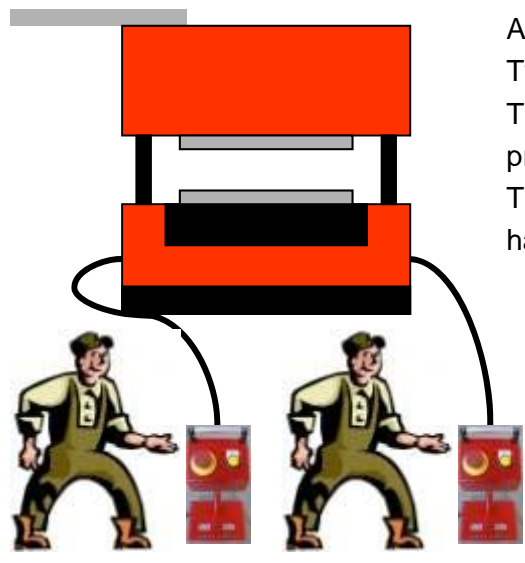

Allows two operators to bend workpieces together. Two foot pedals are used in this example. The ram closes only when the two operators simultaneously press their two foot pedals. This reduces the risk of the auxiliary operator getting the hands pinched.

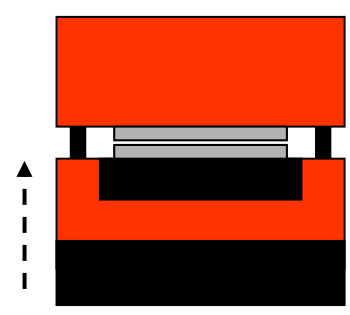
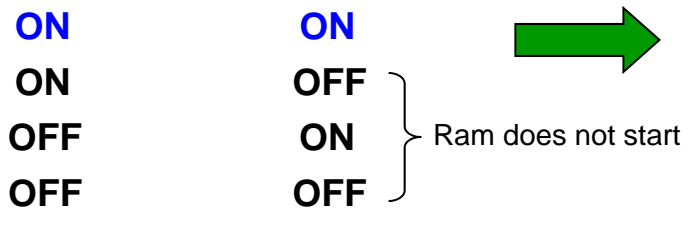

(11) Fly-off prevention dies

A.L.D. dies combine hardness and toughness. This combination reduces the risk of the broken pieces fly off should the A.L.D. die break.

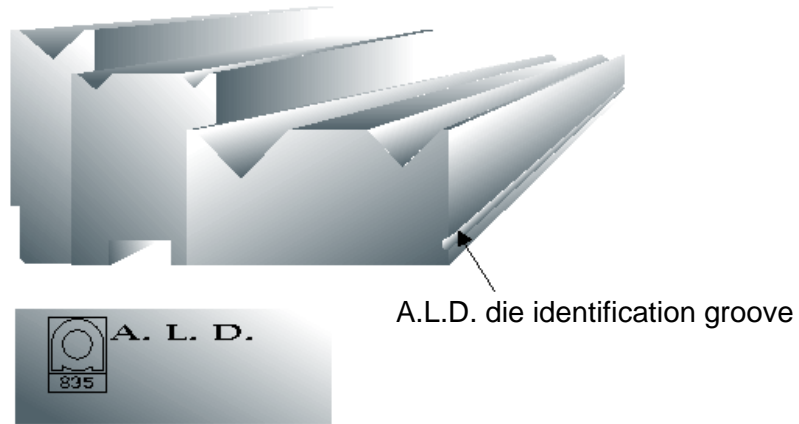

Reference: Setting ram stroke length

Set the ram stroke length to 6 mm or less, if possible with parts to bend.

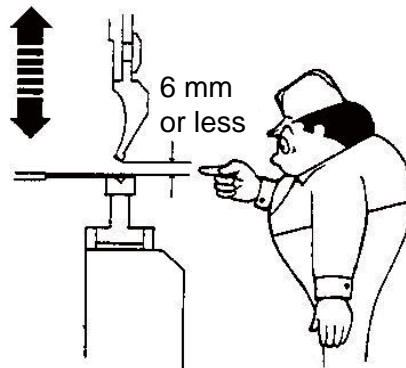

Robotic press brakes

AMADA offers robotic press brakes.



Note: Safety fences are removed for the ease of seeing machine configuration.

Features

The robotic press brakes are intended for use in mass production. The robot works in place of the operator. This means that the operator needs not enter the moving range of the machine during continuous bending.

A safety fence is erected around the moving range of the robot to eliminate the interference between the robot and operator.

The separation of the operator from the machine reduces hazards to the operator during bending.

Safeguarding device selection table

Open circles (O) indicate recommended safeguarding devices.

Task Safeguarding device	Setup/ adjustment	General bending	Box bending	Special bending	Cleanin g	Reference information
(1) Light curtain	O	O			O	
(2) Laser beam device	O	O	O	O	O	
(3) Side guards	O	O	O	O		Protection at sides of machine during operation Particularly effective for protecting operators other than main and auxiliary operators
(4) Rear guard	O	O	O	O		Protection at rear of machine during operation Particularly effective for protecting operators other than main and auxiliary operators
(5) Three-position foot pedal	O	O	O	O	O	
(6) Sheet follower		O	O			Effective for bending large parts and boxes
(7) Stepped stopper fingers		O	O			
(8) Two-hand control device		O				Parts that can be bent without support
(9) Automatic stroke stop device		O	O	O		Effective for bending small parts
(10) Two-person control device		O				Two operators simultaneously use two foot pedals
(11) Fly-off prevention dies	O	O	O	O		

Some safeguarding devices cannot be retrofitted, depending on type of machine. For details, contact AMADA.

Request for provision of accident information

On April 15, 2014, the Labour Standards Bureau of the Ministry of Health, Labour and Welfare issued the LSB Notification No. 0415-1 "Procedure for Promoting Provision of Disaster Information, etc., from Machine Users to Machine Manufacturers, etc."

The notification obligates machine manufacturers to clearly state contact points, contact methods and accident information and other contact items in instruction manuals, etc., and machine users to furnish information to machine manufacturers and to take measures for preventing the recurrence of accidents, etc., in coordination with machine manufacturers.

Following the notification, Amada intends to collect accident information from our customers and use it to prevent the recurrence of similar accidents with our machines and to promote greater safety in the design and manufacturing stages of our machines. We kindly ask for your cooperation.

(1) Contact point

Report accident information, etc., by telephone or otherwise to our sales office service center in your area.

(2) Information to be provided

Furnish to us accident information concerning the contact items described in the following accident report.

Accident report

Date reported mm/dd/yy	● Overview of accident
Classification of accident: 1. Occurrence or likelihood of injury or fatal accident 2. Occurrence or likelihood of fire accident	Date and time of accident occurrence: mm/dd/yy Approximately hh:mm
● Customer	[Injury or fatal accident]
Company name (department name):	Victim: 1. Operator 2. Other than operator ()
Name (position):	Sex (age): 1. Male 2. Female (xx years old)
Address:	Accident situation (body part and degree of injury):
Telephone number:	[Fire accident]
Fax number:	Ignition source and ignited material (if determinable):
E-mail address:	Burnt range:
● Amada machine used (Information stamped on serial plate)	Work and process leading to accident:
Model:	Usage of protective equipment:
Manufacture number:	Comment from customer:
Manufacture date: mm/yy	



AMADA hopes that this safety guide book will help you to provide a safe workplace for your press brake operators.
If you have something to know about the safeguarding of press brakes or need more information or proposals, contact AMADA.

AMADA CO.,LTD.
200, Ishida, Isehara-shi, Kanagawa 259-1196, Japan
0463-96-1111
<http://www.amada.co.jp/>